

# SANGEAN

# SANGEAN

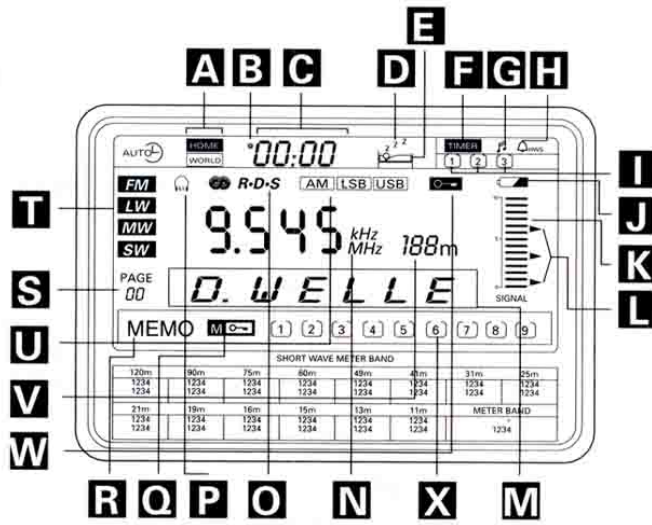

## ATS-909



37

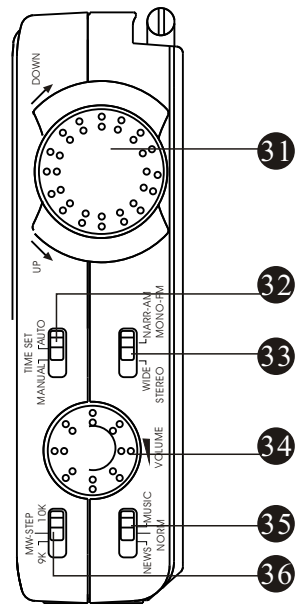
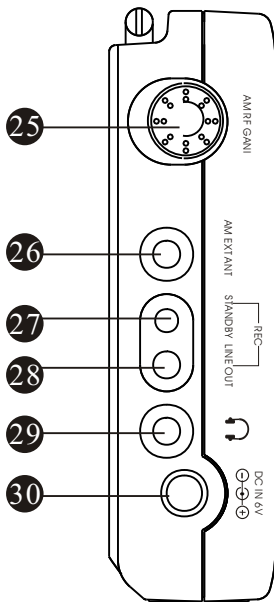
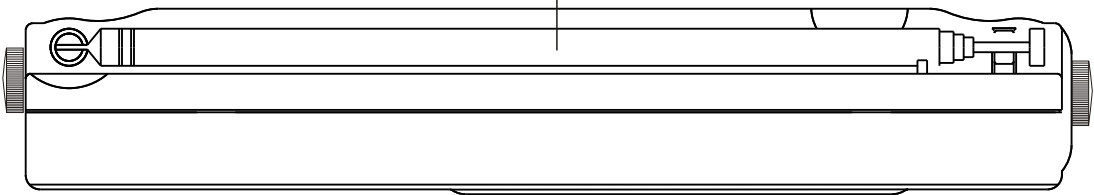

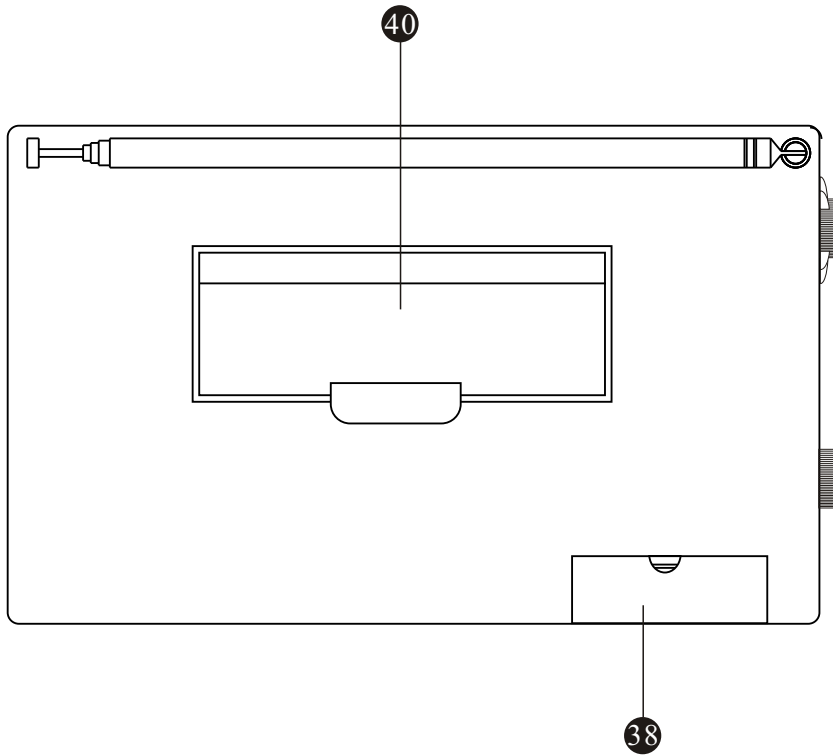
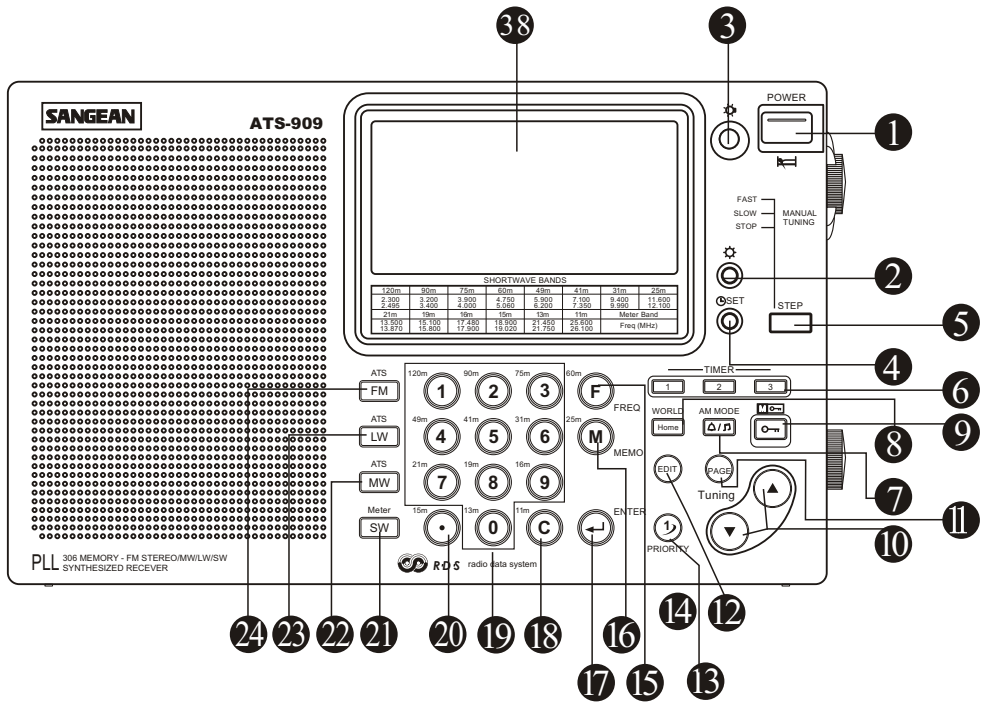



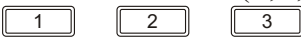















FIG	BUT/SW MARKING	FUNCTION
1	POWER	PWR. ON/OFF/ALARM OFF/SLEEP FUNCTION
2		DAYLIGHT SAVINGS TIME SWITCH
3		DISPLAY LIGHT
4	 SET	TIME SET
		<b>BAND</b>
5	MANUAL TUNING/STEP	<b>FM</b>
		<b>LW</b>
		<b>MW</b>
		<b>SW</b>
		<b>AM USB/LSB</b>
		<b>Step</b>
		<b>Fast</b> 100KHz 9KHz 9/10KHz 5KHz 1KHz
		<b>Slow</b> 50KHz 1KHz 1KHz 1KHz 40KHz
6	TIMER	SLEEP TIMERS (1,2,3) 
7	MODE 	SELECT MODE (SELECTS USB/LSB/AM AND WAKE-UP ALARM BY RADIO OR HWS BUZZER)
8	WORLD 	HOME/WORLD TIME SELECTION
9	LOCK 	LOCK SWITCH (LOCKS ALL SETTINGS)
10	UP/DOWN TUNING 	MANUAL TUNING/AUTO TUNING/PAGE SELECTION/EDIT/HOME WORLD TIME SEARCH
11	RAGE 	PAGE SELECTION: 2 PAGES MW/FM 1 PAGE LW 29 PAGES SW
12	EDIT 	EDIT/CREATE STATION NAME AND HOME/WORLD CITY NAME
13	PRIORITY 	INSTANT RECALL FAVORITE STATION
14	RESET	CLEARs TIME & MICROPROCESSOR
15	FREQ 	ALLOWS DIRECT FREQUENCY INPUT
16	MEMO 	ALLOWS MEMORY INPUT

17		ENTER SELECTION/0 Secretary. TIME SET
18		SELECTION CANCE/11 M SELECT
19		DIGIT INPUT/CLOCK/MEMORY & SW BAND
20		DECIMAL POIN/SW 15 METER BAND
21	METER/SW	SELECTS SW BAND
22	ATS/MW	SELECTS MW BAND/PRESETS ALL STATIONS
23	ATS/LW	SELECTS FM BAND/PRESETS ALL STATIONS
24	ATS/FM	SELECTS LW BAND/PRESETS ALL STATIONS
25	AM RF GAIN	ADJUSTS LEVEL OF INCOMING SIGNAL TO PREVENT OVERLOAD AND DISTORTION
26	AMEXT ANT	JACK FOR EXTERNAL AM ANTENNA
27	REC/STAN BY	TURN-ON FOR EXTERNAL RECORDER
28	REC/LINE OUT	AUDIO OUTPUT
29		HEADPHONE JACK
30	DC IN 6VDC	JACK FOR EXTERNAL 6VDC POWER ADAPTER
31	ROTARY TUNING KNOB	EDIT CHARACTERS SELECTED/FREQUENCY ADJUSTMENT, HOME-WORLD CITY SELECTION, SW PAGE SELECTION
32	TIME SET	SELECTS AUTO OR MANUAL MODE FOR TIME SET
33	WIDE NARROW	AM WIDE/NARROW FILTER/FM MONO STEREO SELECTOR
34	VOLUME	ADJUSTS VOLUME LEVEL
35	TONE	TONE CONTROL (NEWS, MUSIC, NORMAL)
36	MW STEP	US/FOREIGN STATION FREQ. SPACING, (9KHz/10KHz)
37	TELESCOPING ANTENNA	
38	LCD DISPLAY	
39	BATTERY COMPARTMENT	
40	FOLDING STAND	

## DISPLAY ICONS

- a. HOME/WORLD TIME
- b. DAYLIGHT SAVINGS TIME
- c. TIME

- d. SNOOZE ICON
- e. SLEEPTIMER ICON
- f. TIMER
- g. RADIO WAKE-UP
- h. HWSBUZZER WAKE-UP
- i. SELECTED TIMER
- j. BATTERY SYMBOLICON
- k. SIGNAL/BATTERY LEVEL
- l. ROTARY TUNING SPEED
- m. STATION/CITY
- n. FREQUENCY
- o. RDS SYMBOL
- p. FM STEREO INDICATOR
- q. MEMORY LOCKED
- r. MEMORY PRESETS
- s. PAGE
- t. BAND SELECTED
- u. AM MODE SELECTION(AM,LSB,USB)
- v. SW METERBAND
- w. SYSTEMLOCK
- x. DIGIT FOR MEMORY SLOT

## **POWER SUPPLY**

The ATS-909 operates on 4 AA Batteries. If an external adapter is used it must be capable of providing 6.0VDC,300ma. With center connector negative.

## **CHANGING BATTERIES**

Press and remove battery cover in the direction as indicated by the arrow on the cover.Insert 4AA batteries with polarities exactly as shown on diagram next to battery cover. Side battery cover back into place in direction of arrow until case snaps into place.

Each time the ATS-909 is turned off the battery icon and battery level indicator will remain on for approximately 7 seconds.Batteries should be replaced when level indicator drops to 2/and or the battery symbol flashes.

Batteries must be replaced within 3 minutes to retanin clock display.(Input memory will remain intact even during power failure because receiver is equipped with EEPROM memory)

## **USING EXTERNAL AC ADAPTER**

The ATS-909 can be used on AC by using the SanganAC Adapter included with this radio. When connected the batteries within the radio will be automatically disconnected.

## **SETTING THE CLOCK(REAL TIME)**

In keeping with wold wide short wave protocol time is programmed on a 24 hour basis. (Greenwich

Mean Time).

The clock can be set with the power on or off. The clock display will start to run as soon as batteries are inserted. Press button (4) (Time Set). Display time digit will be blank and Home display will flash. Use digital buttons (19) to enter the actual time in hours and minutes. (Don't forget time must be entered on a 24 hour basis). Once entered, hours and minutes will be displayed in display. To start clock press (17) (↔)

To cancel an incorrect entry press button 18 (C). One digit is deleted every time the button is pressed.

## SETTING WORLD TIME

The ATS-909 is preprogrammed to provide the correct time for 42 cities worldwide. Each city's time is correct once your own city time zone is inserted into the system.

Once you have inserted the correct time for your city as described previously push button 8 [ HOME ] (World/Home). Home display will begin to flash. Using rotary knob 31 select your city or any designated city that shares your same time zone and push button (↔). Displayed city will remain for about 2 seconds and disappear. To recall home city press Home/World button again. Once above is completed it is only necessary to press World/Home button and use rotary knob 31 to get the correct time in any city displayed.

## ADDING YOUR OWN WORLD CITY

You may program 1 world city of your choice into the receiver if it is not among the 42 cities already programmed into the receiver.

Push Home/World button. Home display will flash. Using Rotary Knob select correct city/time zone required. Press button 12 (Edit Button) and using Rotary knob and up/down buttons (10) enter the correct city name you desire. When name is completely entered press button (17) (↔).

## RADIO OPERATION

The selection of radio bands FM/LW/MW/SW is made by selecting buttons (21-24).

<u>Button</u>	<u>Band</u>	<u>Frequency Range</u>	<u>Wavelength</u>
24	FM	87.5-108 MHz	VHF/FM
23	LW	153-513 kHz	Long wave
22	MW(AM)	520-1710 kHz	Medium Wave
21	SW	1711-29999 kHz	Short Wave

The ATS-909 is a continuously tunable receiver from 153 kHz-29999 Khz. This receiver is capable of receiving and tuning all the short wave bands and any stations in between.

## TUNING METHODS

This receiver offers 5 methods of frequency tuning:

ATS-Auto Tuning	This system automatically sets your memory presets based upon the signal strength of the received station
Direct Tuning	Frequency of desired station is entered into receiver using key pad on receiver
Manual Tuning	Station is selected by manually using Rotary Knob.
Scan Tuning	Pressing and momentarily holding UP/DOWN will automatically scan frequency band and stop when a station is detected
Memory Tuning	Stations preselected using memory will be selected merely by pressing digital buttons on key pad.

### ATS-Automatic Tuning System

The ATS-909 features an automatic tuning system that will quickly and automatically set all your memory presets on FM, LW and MW based upon the signal strength of the incoming stations. Among the many conveniences offered by this feature it is especially useful for the traveler who can automatically find all the local stations in any strange city he may travel to with just the push of a button..

To start ATS press and hold for more then 2 seconds the buttons designated ATS/FM or ATS/LW or ATS/MW. The display will flash ATS and the memory presets M1 through M9 are assigned stations selected automatically by the ATS system. The ATS system will automatically store 18 presets on MW and FM and 9 presets on LW. (9 presets on each page. Once the ATS has set the 9 presets on 1 page press the Page button to change pages and repeat the ATS-procedure to select the remaining presets). An audible signal indicates the automatic search has been completed and the presets have been assigned. ATS is not possible on the SW Bands.

### DIRECT TUNING USING KEY PAD

If you know the frequency of the station you are seeking press button(15) [ **FREQ** ] and enter the frequency you desire directly using the numerical key pad. Don't forget to use the decimal point button if the frequency you are entering has a decimal point in its frequency. Press button (17) [ **←** ] to enter the frequency.

### MANUAL TUNING (ROTARY TUNING)

Manual Tuning is accomplished using the convenient Rotary Tuning Knob(31).

The Step button (5) is used to determine the tuning spread for each step of the Rotary Tuning Knob. Spread may be changing accordingly:

<b>BANDS</b>					
	FM	LW	MW	SW	AM USB/LSB
<b>STEP</b>					
Fast	100 KHz	9 KHz	9/10 KHz	5 KHz	1 KHz
Slow	50 KHz	1 KHz	1 KHz	1 KHz	40 Hz

### **AUTO/MANUAL SCANTUNING**

To start Auto Scan Tuning select band to tune and press one of the tuning buttons (10) for more than 1/2 second. Once scan starts release button. The Auto Scan stops as soon as a station of adequate signal strength is located. Repeat operation to start scan again. Scan can be halted by pressing the tuning button (10) momentarily any time during the scanning process.

To manually tune to a frequency of your choice hold down one of the tuning buttons (10) until the frequency desired is displayed.

### **MEMORY TUNING**

It is possible to preset up to 306 stations using memory capability of the ATS-909. Each 9 presets compromise 1 page. The SW band is capable of storing 29 pages or 261 preset stations (29 Pages x 9 Presets/Page): 18 Presets on FM and MW (2 Pages 9 Presets)and 9 presets on LW.

#### To Manually Set Memory on FM/MW/LW Bands:

Tune to station you would like to program into memory. Press memo button (16)[M], MEMO will flash in LCD display, select page desired by pressing PAGE button[11].Display will flash and next available position on display will flash if an available. If memory is full no suggested position will flash and LCD will display MEMOFULL when any button is depressed. Press (←) button to assign new frequency to available flashing open position, If selected button is held for more than 2 seconds, even with MEMOFULL flashing, newly selected station will replace existing station.

#### To Manually Set Memory on SW Bands:

Tune to station you would like to program into memory. Press memo button (16)[M], MEMO will flash in LCD display. Select page desired by using UP/DOWN button [10]. Display will flash and next available position on display will flash if an available position is available. Press (←) button to assign frequency to flashing available position. If memory is full no suggested position will flash and LCD will display MEMOFULL when any button is depressed. If selected button is held for more than 2 seconds, even with MEMOFULL flashing, newly selected station will replace existing station.

You may change or initiate any page name at any time by first selecting the page and then pressing the edit button (12)[EDIT] and using the Rotary Knob(31) to place an alphanumeric character in the name

Space in the LCD Display. Once a character is selected you may move to the next position to place another character by using the UP/DOWN button (10). When name is completely entered press (←) button.

## RECALLING A STATION IN MEMORY

On LW, press ATLS/LW button (23), then press any of the numbered buttons on the key pad.

On MW/FM, press ATLS/MW button (22) [MW] or press ATLS/FM button (24), select desired page by pressing page button (11) [PAGE] and then press any of the numbered on the key pad.

On SW, press SW button (21) [SW], select desired page by pressing page button (11) [PAGE] and UP/DOWN button (10) until desired page is selected and then push ENTER button (17) (↵). The receiver will then automatically search for the strongest frequency on that page. You may change the selected frequency using the numbered keys on the pad.

## CANCELING A STATION IN MEMORY

Recall the station in memory, press the memo button (16) [M] and then press the cancel button (18) [C].

## LOCKING A STATION INTO MEMORY

After programming your stations into memory you may lock any station into memory to prevent accidental erasure or elimination should the ATLS feature be turned on again.

To lock a station recall the station you wish locked and press **MEMO** button (16) [M] and then lock button (9) [🔒]. The display will show memo locked symbol whenever that station is selected. To remove station from locked position repeat above procedure and locked symbol will be removed and station will no longer be in locked state.

## EXCHANGING STATION POSITIONS IN MEMORY

To move a station in memory to another position recall station. Press **MEMO** button (M), MEMO and position display will flash, press new position desired and a signal will be heard indicating the exchange has taken place and the positions have been swapped.

## SELECTING A SW BAND

To select a SW Band press METER/SW button (21) once and then press a second time. A flashing *m* will appear in the display. Any of the 14 SW Bands (11-120M) can now be selected. The band selected appears in the LCD display and will remain in the display as long as tuning activity remains within the metered band.

Band ranges are indicated in a convenient chart above the numbered keys on the key pad.

## DIRECT BUTTON (Instant Priority)

The PRIORITY button (13) [🔑] allows instant recall to your favorite station from any frequency or band by.

Simply pressing one button. To program the Direct button recall your favorite station, press MEMO button (16) [M] and then press PRIORITY button (13) [ **1** ].

## **ALARM FUNCTION**

The ATS-909 has three timer circuits as indicated by TIMER button (6) [1] [2] [3]. The alarm function may be set with the power on or off. To set the alarm tune to the station you would like to be awakened to. Press MEMO button [16]. Press one of the three timer buttons (6) [1] [2] [3]. The timer and button number will flash in the LCD display along with the icon indicating radio or buzzer for approximately 12 seconds. Select radio or buzzer by pressing MODE button (7). While flashing continues set time or alarm to come on using the numerical keys (19) on the key pad. When complete press ENTER key (17). Repeat steps for other timers.

In addition to being able to set 3 different wake up times it is possible to set each wake up time to a different frequency.

## **SETTING THE SLEEP TIMER (AUTO SHUT-OFF)**

The sleep timer allows the user to set the auto-shut off in 10 minutes decrements from 90 minutes to 10 minutes. To set auto shut-off press POWER/SLEEP button [1] and hold down. The display will show a bed symbol and a series of switch off times descending in time as long as the POWER/SLEEP button is depressed. Release button when shut off time desired is reached. Radio will remain on for selected length of time.

## **RDS FUNCTION**

The ATS-909 incorporates circuitry to receive FM stations transmitting an RDS (Radio Data System) signal. When receiving an RDS station the display will show the station call letters and if the RDS station is also transmitting a CT function (clock time) it will automatically correct the time every minute. It is important to make sure that the Home Time (as described under "SETTING THE CLOCK (REAL TIME)" is set correctly. In addition if your time zone is operating under Daylight Savings Time make sure the DST (Daylight Savings Time) button [2] is depressed. For the time function to operate the following conditions must exist:

- a: TIME SET switch button (32) must be set in the AUTO position.
- b: Radio must be on.
- c: Radio must be tuned to an FM station transmitting RDS CT function.

## **SINGLE SIDE BAND (SSB) RECEPTION**

SSB is very popular among ham and business radio users because of its signal intelligibility superiority. Many amateurs who operate SSB and transmit below 10 MHz generally use the lower side band (LSB) while amateur and commercial stations transmitting above 10 MHz generally use the USB. Your ATS-909 is equipped to receive all USB and LSB transmissions. To receive SSB stations:

- 1] Turn the set on.
- 2] Extend the telescoping antenna full length and position upright or use external antenna.
- 3] Set the RF Gain Control [25] to maximum.
- 4] Select the SW band as described in "SELECTING A SW BAND"
- 5] If frequency of SSB station sought is known enter the frequency in accordance with earlier

## Instructions.

- 6] You may also scan the band for SSB stations by slowly rotating the Rotary Tuning Knob [31] through the selected band, tuning for the best intelligibility and watching for deflections on the Signal Strength Indicator [k] in the display. (SSB transmit with a "suppressed carrier" meaning the Signal Strength Indicator [k] in the display will fluctuate only when there is a voice transmission and not during pauses in voice transmission.
- 7] As soon as you have located a SSB station (you will not be able to understand the speech) switch to SSB reception by depressing the MODE button [7]. Continued pressing of the MODE button [7] will alternate between USB and LSB. Try LSB for frequencies below 10 MHz or USB for frequencies above 10 MHz.
- 8] After tuning for maximum intelligibility switch MANUAL TUNING/STEP switch [5] to Slow position and readjust Rotary Tuning Knob [31] for maximum intelligibility.

## SWITCH SETTINGS

### AMNARROW/WIDE(Switch 33)

For normal operation it is suggested that this switch be used in the wide position. If occasion arises where a near-by station interferes with the station being listened to the AM Narrow/Wide switch should be put into the narrow position.



### STEREO RECEPTION

The ATS-909 is designed to receive FM stereo broadcasts with headphones connected to the stereo headphone jack [29]. Switch 33 FM STEREO/MONO must be placed in the stereo position. Stereo icon will appear in LCD display if headphones are connected.

### VOLUME CONTROL

To adjust the volume control [34] to a comfortable position. Make sure that control is set to an adequate level when radio is set for waking up.

### OPERATING LOCK (BUTTON 9)[ ]

The operating lock prevents unintentional altering of any of the functions once set or accidentally turning off the radio. Once set the ON/OFF switch and all tuning options become unalterable and can not be reactivated until the lock switch is turned off. It is a good policy to turn on the lock switch when transporting the radio as it will prevent the radio from being turned on accidentally while in a bag or suitcase. To turn the lock switch on press switch (9) []. When the lock switch is the ON position a lock symbol [] will appear in the display. To unlock radio press switch (9) [] again. This will unlock the radio and remove the lock symbol from the display.

### AERIALS

The ATS-909 comes equipped with an integrated ferrite antenna built into the radio that should provide more than adequate reception for the MW and LW bands. For FM and SW reception it is advised that the telescoping antenna be extended and adjusted in length and direction for maximum results.

## ANT-60 PORTABLE SW ANTENNA

Included with the ATS-909 is the Sangean ANT-60 Portable SW Antenna. The antenna is plugged into jack (26) labeled EXT AM ANT. When fully extended this antenna should improve SW reception. For maximum performance this antenna should be placed as high as possible above the ground and in an unobstructed area if possible.

## MW STEP (36)

This switch should be set for 10 kHz when listening to radio stations in the United States and Canada. In many countries overseas it may be necessary to switch to 9kHz to receive local broadcasting stations at the correct frequency.

## RESET SWITCH

The Reset Switch (14) situated at the bottom of the receiver case will reset the Time and Microprocessor only. All memory presets will remain intact. Reprogram time in accordance to earlier instructions.

## LCD DISPLAY LIGHT

Switch (3) [  ] is used to illuminate the display when it becomes too dark to see the display. The light will remain on approximately 12 seconds after initiated or will extinguish should any other function be activated.

If an AC adapter is being used the LCD display will be illuminated continuously while the radio is in operation.

## **TECHNICAL DATA**

WAVEBANDS	FREQUENCY
FM(VHF)	87.5-108 MHz
MW	520-1710 kHz
LW	153-519 kHz
SW (Short Wave)	1.711-29.999MHz

SHORT WAVE BAND	FREQUENCY (MHz)
120M	2.300-2.495
90 M	3.200-3.400
75 M	3.900-4.000
60M	4.750-5.060

49M	5.900-6.200
41M	7.100-7.350
31M	9.400-9.990
25M	11.600-12.100
21M	13.500 13.870
19M	15.100 -15.800
16M	17.480-17.900
15M	18.900-19.020
13M	21.450-21.750
11M	25.600-26.100

## **BATTERIES**

4x1.5 Volt (AA)

External Power Supply: 6.0VDC/300mA/Negative Polarity Center

Dimensions in inches: (WxHxD): 8 1/4x5.0x1 1/2

Weight in oz: 30